

JAL-KR8-OV5640-1B V2.2 NIR

5MP OmniVision OV5640-1B DVP Parallelschnittstelle Kein IR-Kameramodul mit festem Fokus

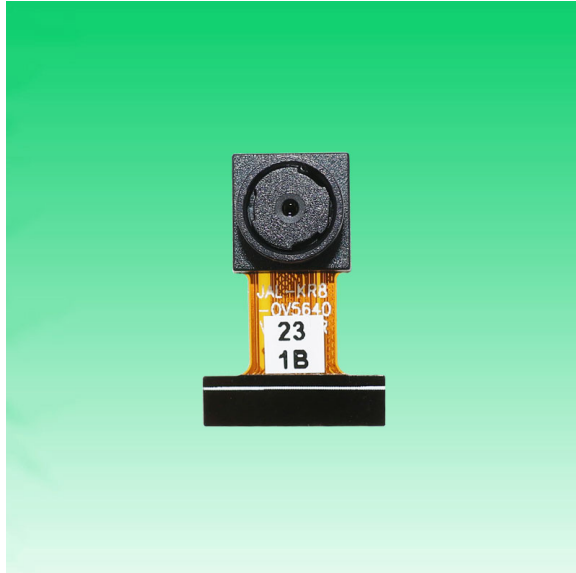

Vorderansicht



Rückansicht

Spezifikationen

Kameramodul Nr.	JAL-KR8-OV5640-1B V2.2 NIR
Auflösung	5MP
Bildsensor	OV5640-1B
Sensorart	1/4"
Pixel Größe	1.4 um x 1.4 um
EFL	3.20 mm
F.NO	2.80
Pixel	2592 x 1944
Betrachtungswinkel	70.0°(DFOV) 58.6°(HFOV) 45.3°(VFOV)
Linsenabmessungen	8.00 x 8.00 x 5.20 mm
Modulgröße	18.50 x 12.50 mm
Modultyp	Fester Fokus
Schnittstelle	DVP-Parallel
Autofokus-VCM-Treiber-IC	Eingebettet
Objektivtyp	Keine IR-Filterlinse
Betriebstemperatur	-30°C to +70°C
Gegenstecker	FH12-24S-0.5SH

JAL-KR8-OV5640-1B V2.2 NIR

5MP OmniVision OV5640-1B DVP Parallelschnittstelle Kein IR-Kameramodul mit festem Fokus



Ansicht von oben



Seitenansicht



Untersicht



Gegenstecker

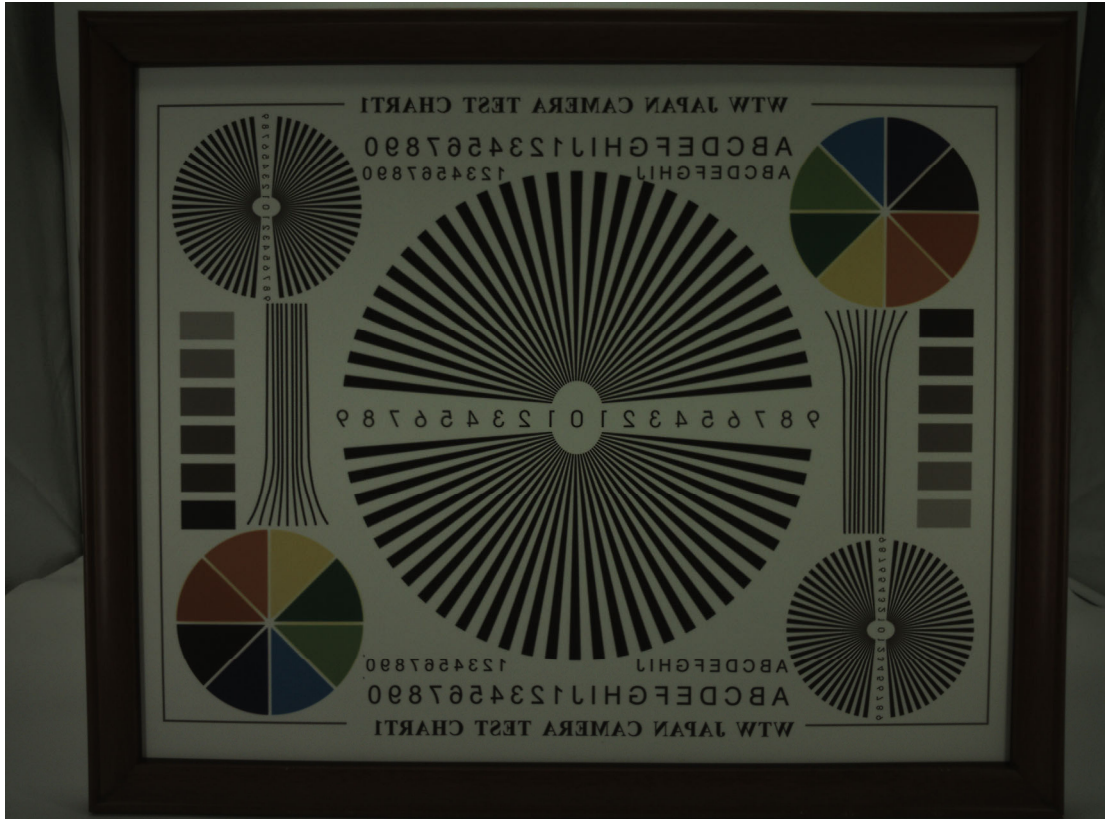

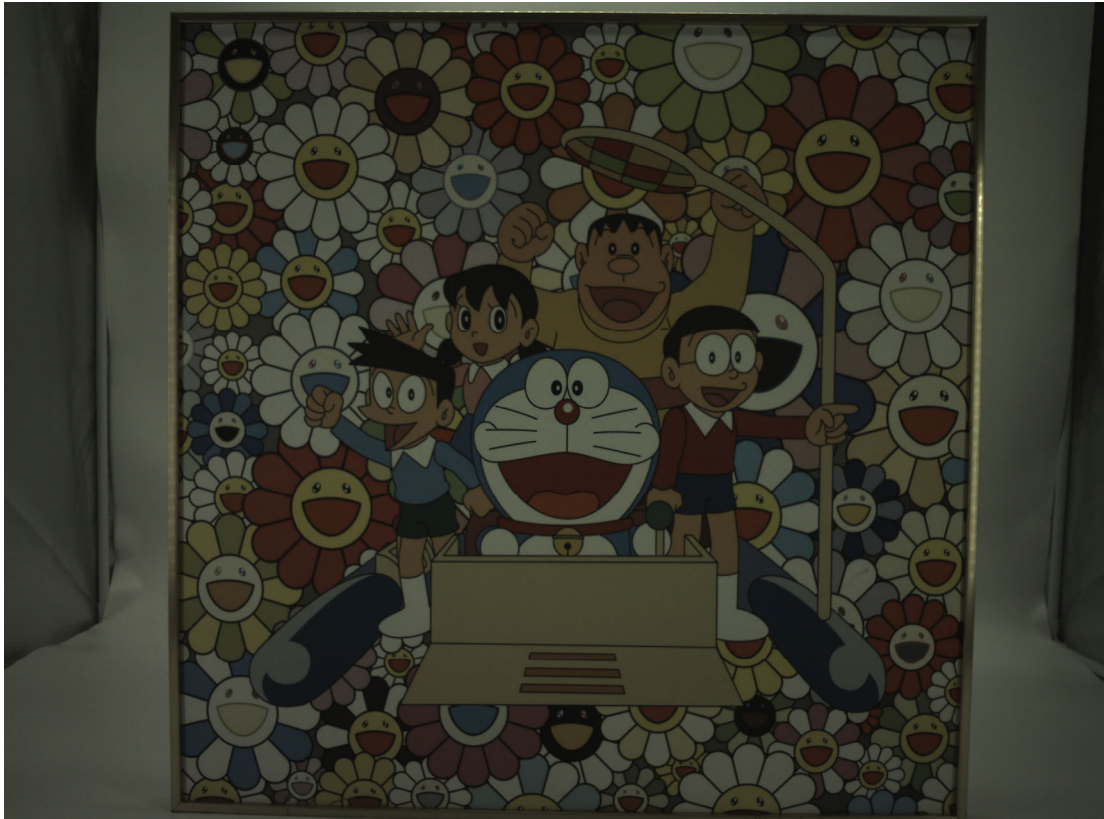



RoHS

PIN SIGNAL

1	NC
2	AGND
3	SIO_D
4	AVDD 2.8V
5	SIO_C
6	RESET
7	VSYNC
8	PWDN
9	HREF
10	DVDD1.5V
11	DOVDD2.8V
12	D9
13	XCLK
14	D8
15	DGND
16	D7
17	PCLK
18	D6
19	D2
20	D5
21	D3
22	D4
23	D1
24	D0

Version	Information	Date
V1.0	First Version	3-12-2016
V2.0	Change lens/capture direction and the PIN order	2-8-2017
V2.2	Change lens	12-29-2021

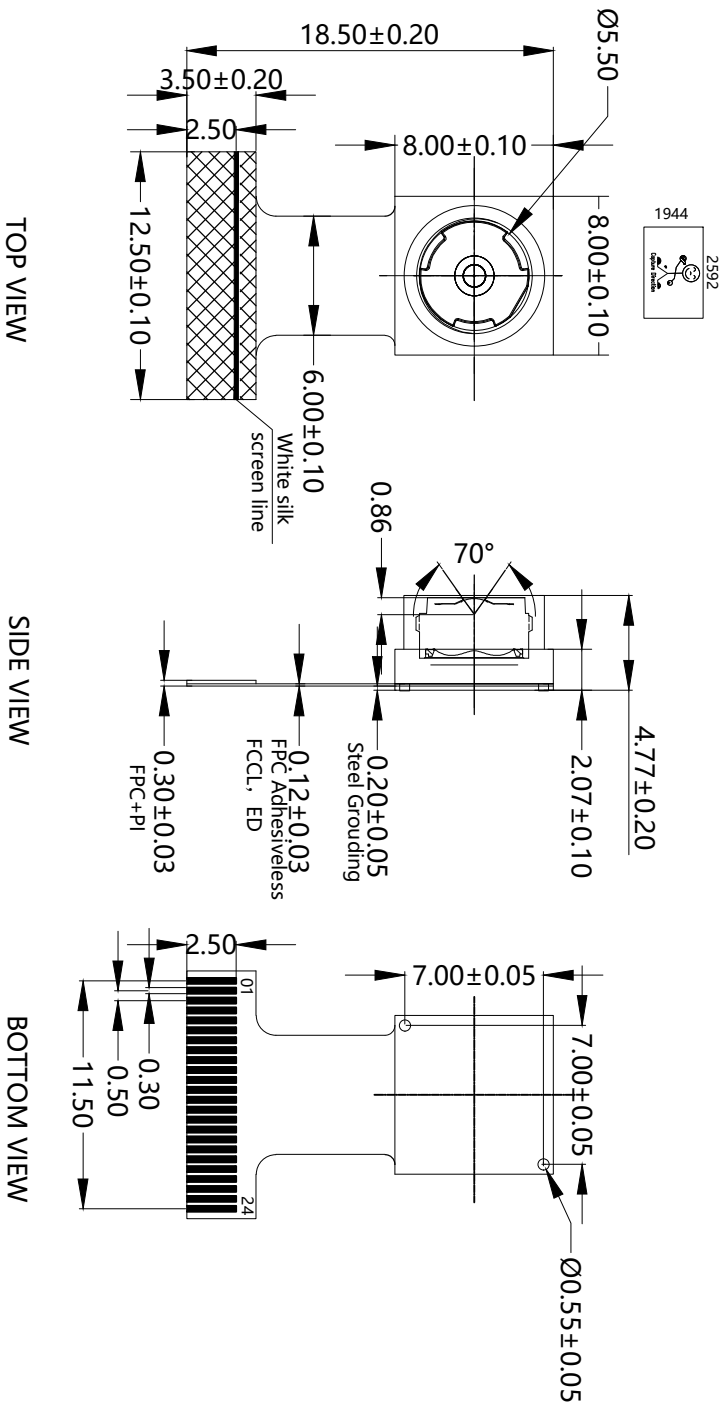

Parameters:

- 1、 Sensor specification:
Image Sensor: OV5640-1B
Pixel: 1.4um*1.4um
Lens Type: 1/4
- 2、 Lens specification:
FOV: 70°(D);58.6°(H);45.3°(V)
F/NO.: 2.8
TV distortion: <1.0%
Focal length: 3.2mm
Composition: 4P(NO IR FILTER)
- 3 Important Voltage Description:
DVDD1.5V (external power supply);

Kai Lap Technologies Group Ltd

Designed By	Kevin	Model Name:	JAL-KR8-OV5640-1B V2.2 NIR
Checked By	Aouly_Yan	Projection Type:	Third Angle
		Unit:	mm
		Scale:	1:1
		Material:	-----
		Sheet:	1 of 1
		Version:	1/0

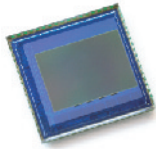

OV5640 5-megapixel product brief



1/4-inch, 5-Megapixel SOC Image Sensor Optimized for High-Volume Mobile Markets



available in
a lead-free
package

The OV5640 delivers a complete 5-megapixel camera solution on a single chip, aimed at offering cost efficiencies that serve the high-volume autofocus (AF) camera phone market. The system-on-a-chip (SOC) sensor features OmniVision's 1.4 micron OmniBSI™ backside illumination architecture to deliver excellent pixel performance and best-in-class low-light sensitivity, while enabling ultra compact camera module designs of 8.5 mm x 8.5 mm with <6 mm z-height. The OV5640 provides the full functionality of a complete camera, including anti-shake technology, AF control, and MIPI while being easier to tune than two-chip solutions, making it an ideal choice in terms of cost, time-to-market and ease of platform integration.

The OV5640 enables 720p HD video at 60 frames per second (fps) and 1080p HD video at 30 fps with complete user control over formatting and output data transfer. The 720p/60 HD video is captured in full field of view (FOV) with 2 x 2 binning, which doubles the sensitivity and improves the signal-to-noise ratio (SNR). Additionally, a unique post-binning re-sampling filter function removes zigzag artifacts around slant edges and minimizes spatial artifacts to deliver even sharper, crisper

color images. To further improve camera performance and user experience, the OV5640 features an internal anti-shake engine for image stabilization, and it supports Scalado™ tagging for faster image preview and zoom.

The OV5640 offers a digital video port (DVP) parallel interface and a high-speed dual lane MIPI interface, supporting multiple output formats. An integrated JPEG compression engine simplifies data transfer for bandwidth-limited interfaces. The sensor's automatic image control functions include automatic exposure control (AEC), automatic white balance (AWB), automatic band filter (ABF), 50/60 Hz automatic luminance detection, and automatic black level calibration (ABLC). The OV5640 delivers programmable controls for frame rate, AEC/AGC 16-zone size/position/weight control, mirror and flip, cropping, windowing, and panning. It also offers color saturation, hue, gamma, sharpness (edge enhancement), lens correction, defective pixel canceling, and noise canceling to improve image quality.

Find out more at www.ovt.com.

applications

- cellular phones
- toys
- PC multimedia
- digital still cameras

ordering information

- **OV05640-A71A-1B** (color, lead-free)
71-pin CSP

features

- 1.4 μm x 1.4 μm pixel with OmniBSI technology for high performance (high sensitivity, low crosstalk, low noise, improved quantum efficiency)
- optical size of 1/4"
- automatic image control functions: automatic exposure control (AEC), automatic white balance (AWB), automatic band filter (ABF), automatic 50/60 Hz luminance detection, and automatic black level calibration (ABLC)
- programmable controls for frame rate, AEC/AGC 16-zone size/position/weight control, mirror and flip, cropping, windowing, and panning
- image quality controls: color saturation, hue, gamma, sharpness (edge enhancement), lens correction, defective pixel canceling, and noise canceling
- support for output formats: RAW RGB, RGB565/555/444, CCIR656, YUV422/420, YCbCr422, and compression
- support for video or snapshot operations
- support for internal and external frame synchronization for frame exposure mode
- support for LED and flash strobe mode
- support for horizontal and vertical sub-sampling, binning
- support for minimizing artifacts on binned image
- support for data compression output
- support for anti-shake
- standard serial SCCB interface
- digital video port (DVP) parallel output interface and dual lane MIPI output interface
- embedded 1.5V regulator for core power
- programmable I/O drive capability, I/O tri-state configurability
- support for black sun cancellation
- support for images sizes: 5 megapixel, and any arbitrary size scaling down from 5 megapixel
- support for auto focus control (AFC) with embedded AF VCM driver
- embedded microcontroller
- suitable for module size of 8.5 x 8.5 x <6mm with both CSP and RW packaging

key specifications (typical)

- **active array size:** 2592 x 1944
- **power supply:**
core: 1.425 ~ 1.675V (with embedded 1.5V regulator)
analog: 2.6 ~ 3.0V (2.8V typical)
I/O: 1.8V / 2.8V
- **power requirements:**
active: 140 mA
standby: 20 μA
- **temperature range:**
operating: -30°C to 70°C junction temperature (see [table 8-2](#))
stable image: 0°C to 50°C junction temperature (see [table 8-2](#))
- **output formats:** 8-/10-bit RGB RAW output
- **lens size:** 1/4"
- **lens chief ray angle:** 24° (see [figure 10-2](#))
- **input clock frequency:** 6~27 MHz
- **max S/N ratio:** 36 dB
- **dynamic range:** 68 dB @ 8x gain
- **maximum image transfer rate:**
QSXGA (2592x1944): 15 fps
1080p: 30 fps
1280x960: 45 fps
720p: 60 fps
VGA (640x480): 90 fps
- **sensitivity:** 600 mV/Lux-sec
- **shutter:** rolling shutter / frame exposure
- **maximum exposure interval:** 1964 x t_{ROW}
- **pixel size:** 1.4 μm x 1.4 μm
- **dark current:** 8 mV/s @ 60°C junction temperature
- **image area:** 3673.6 μm x 2738.4 μm
- **package dimensions:** 5985 μm x 5835 μm

0.5mm and 1mm Pitch Connectors For FPC/FFC

FH12 Series

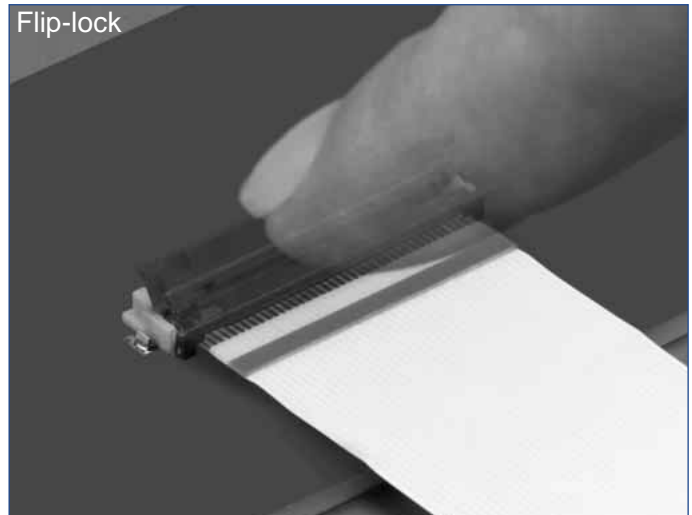
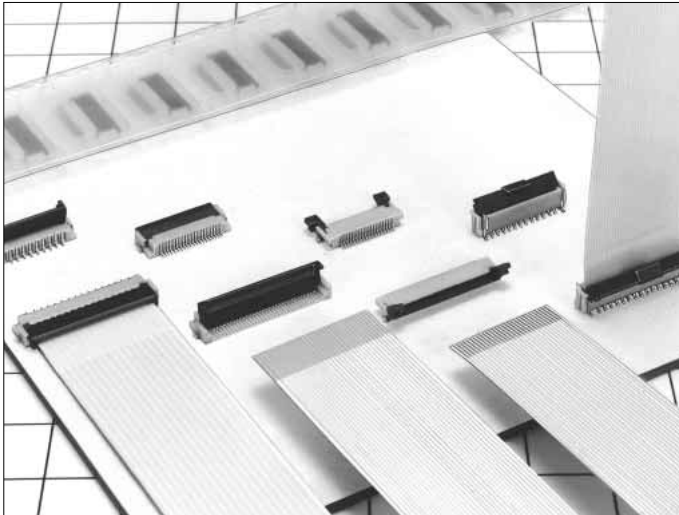

■ Features

1. Ease of Use and Space Savings

Only one finger or 6.9N (Newtons) of force is required to lock Hirose's rotational actuator (flip-lock) as compared to using 2 fingers and 39.2N to close a FFC/FPC connector from our competition.

The Flip-Lock design also allows customers to place 2 or more connectors side by side as there is no need to waste additional board space for a side latch.

2. Strengthened Flip-lock Actuator

The standard Flip-Lock requires only 2.0mm height above the board. A strengthened lock lever is available which only requires an additional 0.4mm.

3. Supports Thin FPC (0.18mm)

Hirose does not require double-sided FPC to have any additional strengthening plate or stiffener and can therefore support a thickness of as little as 0.18mm +/- 0.05.

4. Hirose Ensures Reliability

Hirose's patented half tuning fork contacts maintain the required normal force without relying on the connector housing. With our competitor's conventional products the housing walls support the contact force, which does not provide for long-term reliability.

5. Prevention of Solder Bridge

Excess solder cavity absorbs excessive solder and avoids solder bridging.

6. Three different assembly types

FH12 is offered in Top & Bottom Contact and Vertical Mount and offered in both a 0.5mm contact pitch as well as a 1.0mm contact pitch (bottom contact only).

■ Applications

Notebook computers, printers, PDAs, digital cameras and other compact devices for interconnecting the main circuit board with the LCD, HDD or other device.

Rotating One-touch Mechanism

①

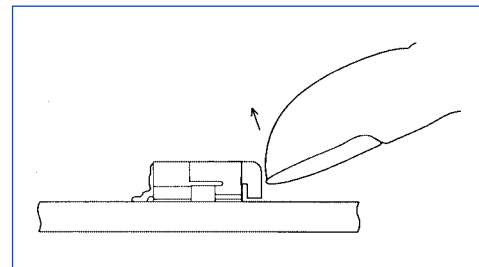

②

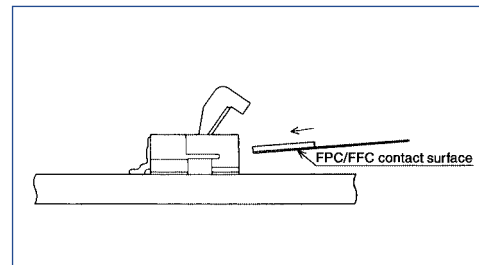

③

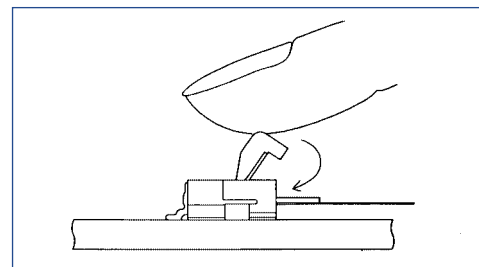

Product Specifications

Rating	Current rating: 0.5A DC(Note 1)	Operating Temperature Range: -40 to +70°C (Note 2)	Storage Temperature Range: -10 to +50°C (Note 3)
	Voltage rating: 50V AC	Operating Humidity Range: Relative humidity, 90% max. (Not dewed)	Storage Humidity Range: Relative humidity, 90% max. (Not dewed)

Applicable FPC	t=0.3±0.05 Gold plated	t=0.18 ± 0.05 for FH12F-*S-0.5SH
----------------	------------------------	----------------------------------

Item	Specification	Conditions
1. Insulation resistance	500M ohms minimum	100V DC
2. Withstanding voltage	No flashover or insulation breakdown.	150V AC/1 minute
3. Contact resistance	50m ohms maximum	1mA
4. Durability (Insertion/withdrawal)	Contact resistance: 50m ohms maximum No damage, cracks, or parts dislocation.	20 cycles
5. Vibration	No electrical discontinuity of 1μs or more Contact resistance: 50m ohms maximum. No damage, cracks, or parts dislocation.	Frequency: 10 to 55 Hz, single amplitude of 0.75 mm, 2 hours in each of the 3 directions.
6. Shock	No electrical discontinuity of 1μs or more Contact resistance: 50m ohms maximum. No damage, cracks, or parts dislocation.	Acceleration of 490 m/s ² , 11 ms duration, sine half-wave waveform, 3 cycles in each of the 3 axis.
7. Humidity(Steady state)	Contact resistance: 50m ohms maximum. Insulation resistance: 50M ohms minimum. No damage, cracks, or parts dislocation.	96 hours at 40°C and humidity of 90% to 95%
8. Temperature Cycle	Contact resistance: 50m ohms maximum. Insulation resistance: 50M ohms minimum. No damage, cracks, or parts dislocation.	Temperature: -40°C → 15 to 35°C → 85°C → 15 to 35°C, Time: 30 → 5 max. → 30 → 5 max.(minutes) 5 cycles
9. Resistance to Soldering heat	No deformation of components affecting performance.	Reflow: At the recommended temperature profile Manual soldering: 350±5°C for 3 seconds

Note 1: When passing the current through all of the contacts, use 70% of the current rating.

Note 2: Includes temperature rise caused by current flow.

Note 3: The term "storage" refers to products stored for long period of time prior to mounting and use. Operating Temperature Range and Humidity range covers nonconducting condition of installed connectors in storage, shipment or during transportation.

Material

Part	Material	Finish	Remarks
Insulator	Polyamide, LCP(60 pos.)	Color : Beige	UL94V-0
Actuator	PPS	Color : Dark brown	
Contact	Phosphor bronze	Gold plated	
Metal Fittings	Brass	Tin plated	

Ordering Information

FH12 **A** - **10** (**4**) - **S** **A** - **0.5** **SH** (**55**)
 ① ② ③ ④ ⑤ ⑥ ⑦ ⑧ ⑨

① Series Name : FH12	⑤ Contact alignment: Single
② Blank : standard type A : Top contact type S : Type with strengthened flip-lock actuator F : Type with 0.18mm FPC End Thickness	⑥ Eccentric direction: Blank : standard type A : Eccentric type
③ Standard type : Number of contacts Eccentric type : Number of contacts in 0.5mm housing	⑦ Contacts Pitch : 0.5mm, 1mm
④ Standard type : Blank Eccentric type : Number of contacts	⑧ Contact type SH : SMT horizontal mounting type SV : SMT vertical mounting type
	⑨ Plating specification (55) : Gold plated

FH12 Series 0.5mm and 1mm Pitch Connectors For FPC/FPC

Series Configuration

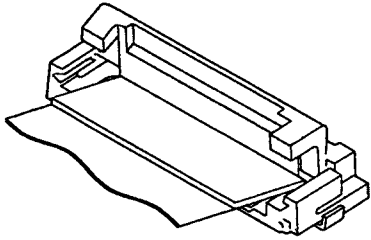
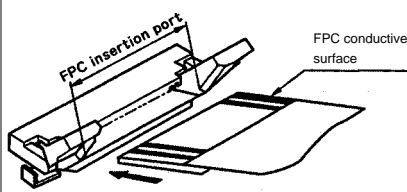
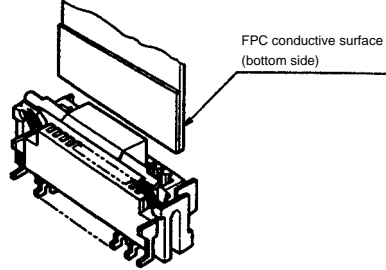
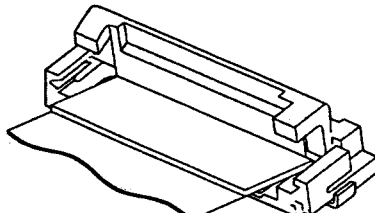
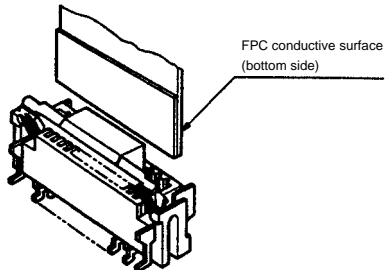
Pitch	Bottom Contact Type	Top Contact Type	Vertical mounting Type
0.5mm	 <p>FH12- ** S-0.5SH P.12 Number of contacts 6, 8, 10, 11, 12, 13, 14, 15, 16, 17, 18, 19, 20, 22, 24, 25, 26, 28, 30, 32, 33, 34, 35, 36, 40, 45, 50, 53</p>	 <p>FPC insertion port FPC conductive surface</p>	 <p>FPC conductive surface (bottom side)</p>
	<p>Type with Strengthened Lock Lever</p>		
	<p>FH12S- ** S-0.5SH P.13 Number of contacts 30, 40, 45, 50, 53</p>		
	<p>Type with 0.18mm FPC End Thickness</p>		
0.5mm	<p>FH12F- ** S-0.5SH P.14 Number of contacts 6, 8, 10, 12, 13, 14, 15, 16, 18, 20, 22, 24, 25, 26, 28, 30, 32, 34, 36, 40</p>	<p>FH12A- ** S-0.5SH P.15 Number of contacts 10, 12, 15, 16, 18, 20, 22, 24, 26, 28, 29, 30, 32, 33, 34, 36, 40, 42, 45, 50</p>	<p>FH12- ** S-0.5SV P.16 Number of contacts 10, 12, 13, 15, 16, 17, 18, 20, 22, 24, 26, 30, 32, 33, 34, 36, 40, 45, 49, 50, 60</p>
	 <p>Standard FH12- ** S-1SH P.18 Eccentric FH12- ** (***) SA-1SH Standard Number of contacts 5, 6, 7, 8, 9, 11, 12, 16, 17, 22, 26 Eccentric Number of contacts 4, 6, 8, 10, 11, 14, 19, 24</p>	 <p>FPC conductive surface (bottom side)</p>	
<p>FH12- ** S-1SV P.19 Number of contacts 6, 7, 8, 16, 20, 22, 24</p>			

0.5mm Pitch Bottom Contact Type

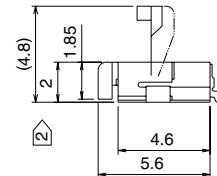
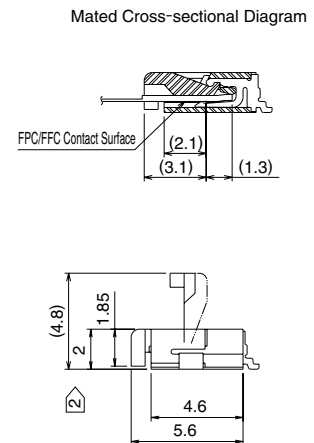
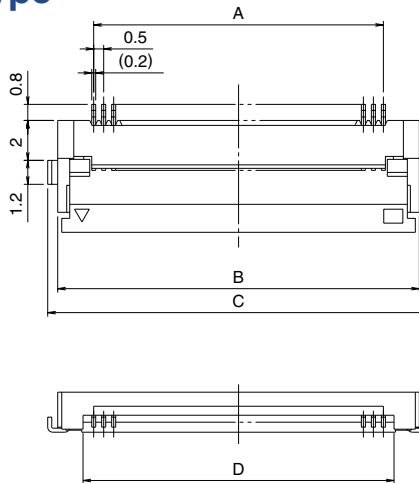

Unit:mm

Part Number	CL No.	Number of Contacts	A	B	C	D	RoHS
FH12- 6S-0.5SH(55)	586-0582-5-55	6	2.5	6.1	7.1	3.57	YES
FH12- 8S-0.5SH(55)	586-0744-5-55	8	3.5	7.1	8.1	4.57	
FH12-10S-0.5SH(55)	586-0522-3-55	10	4.5	8.1	9.1	5.57	
FH12-11S-0.5SH(55)	586-0600-5-55	11	5	8.6	9.6	6.07	
FH12-12S-0.5SH(55)	586-0704-0-55	12	5.5	9.1	10.1	6.57	
FH12-13S-0.5SH(55)	586-0549-0-55	13	6	9.6	10.6	7.07	
FH12-14S-0.5SH(55)	586-0533-0-55	14	6.5	10.1	11.1	7.57	
FH12-15S-0.5SH(55)	586-0523-6-55	15	7	10.6	11.6	8.07	
FH12-16S-0.5SH(55)	586-0531-4-55	16	7.5	11.1	12.1	8.57	
FH12-17S-0.5SH(55)	586-0606-1-55	17	8	11.6	12.6	9.07	
FH12-18S-0.5SH(55)	586-0530-1-55	18	8.5	12.1	13.1	9.57	
FH12-19S-0.5SH(55)	586-0534-2-55	19	9	12.6	13.6	10.07	
FH12-20S-0.5SH(55)	586-0524-9-55	20	9.5	13.1	14.1	10.57	
FH12-22S-0.5SH(55)	586-0532-7-55	22	10.5	14.1	15.1	11.57	
FH12-24S-0.5SH(55)	586-0521-0-55	24	11.5	15.1	16.1	12.57	
FH12-25S-0.5SH(55)	586-0692-3-55	25	12	15.6	16.6	13.07	
FH12-26S-0.5SH(55)	586-0576-2-55	26	12.5	16.1	17.1	13.57	
FH12-28S-0.5SH(55)	586-0612-4-55	28	13.5	17.1	18.1	14.57	
Note ② FH12-30S-0.5SH(55)	586-0525-1-55	30	14.5	18.1	19.1	15.57	
FH12-32S-0.5SH(55)	586-0681-7-55	32	15.5	19.1	20.1	16.57	
FH12-33S-0.5SH(55)	586-0520-8-55	33	16	19.6	20.6	17.07	
FH12-34S-0.5SH(55)	586-0617-8-55	34	16.5	20.1	21.1	17.57	
FH12-35S-0.5SH(55)	586-0740-4-55	35	17.0	20.6	21.6	18.07	
FH12-36S-0.5SH(55)	586-0526-4-55	36	17.5	21.1	22.1	18.57	
Note ② FH12-40S-0.5SH(55)	586-0527-7-55	40	19.5	23.1	24.1	20.57	
Note ② FH12-45S-0.5SH(55)	586-0528-0-55	45	22	25.6	26.6	23.07	
Note ② FH12-50S-0.5SH(55)	586-0529-2-55	50	24.5	28.1	29.1	25.57	
Note ② FH12-53S-0.5SH(55)	586-0595-7-55	53	26	29.6	30.6	27.07	

Note 1 : Embossed tape reel packaging (2,000 pieces/reel).
 Order by number of reels.

Note ② : If there is no problem with the connector height, we recommend the type with the strengthened Flip-lock actuator (FH12S-*S-0.5SH).
 Standard type connector height: 2 mm
 Connector height of type with strengthened Flip-lock actuator: 2.4 mm



Kameraanwendungen

your BEST camera module partner



Autopilot



Live-Streaming



Videokonferenz



Biometrische Eye-Tracker-Erkennung



Maschinelles Sehen



Agrarmonitor



Nachtsichtsicherheit



Drohnen- und Sport-Adleraugen



Interaktive Haustierkamera

www.KaiLapTech.com sales@KaiLapTech.com Tel: (852) 6908 1256 Fax: (852) 3017 6778



Kameraanwendungen

your **BEST** camera module partner

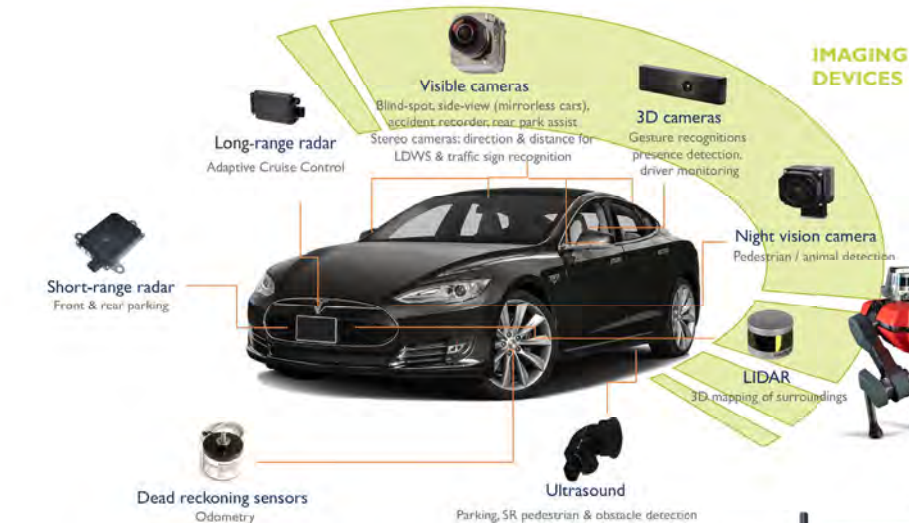

IMAGING DEVICES





Referenztable für die Pinbelegungsdefinition des Kameramoduls

OmniVision Sony Himax Samsung On-Semi Aptina Himax GalaxyCore PixArt Bildsensoren	
Pin Signal	Beschreibung
DGND GND	Masse für digitale Schaltung
AGND	Masse für analoge Schaltung
PCLK DCK	DVP-PCLK-Ausgang
XCLR PWDN XSHUTDOWN STANDBY	Abschalten aktiv hoch mit internem Pulldown-Widerstand
MCLK XVCLK XCLK INCK	Systemeingangsuhr
RESET RST	Aktiv Low mit internem Pull-up-Widerstand zurücksetzen
NC NULL	keine Verbindung
SDA SIO_D SIOD	SCCB-Daten
SCL SIO_C SOIC	SCCB-Eingangstakt
VSYNC XVS FSYNC	DVP-VSYNC-Ausgang
HREF XHS	DVP-HREF-Ausgang
DOVDD	Strom für E/A-Schaltung
AFVDD	Strom für VCM-Schaltung
AVDD	Strom für analoge Schaltung
DVDD	Strom für digitale Schaltung
STROBE FSTROBE	Strobe-Ausgang
FSIN	Synchronisieren Sie das VSYNC-Signal vom anderen Sensor
SID	SCCB letzte Bit-ID-Eingabe
ILPWM	mechanische Shutter-Ausgangsanzeige
FREX	Rahmenbelichtung / mechanischer Verschluss
GPIO	Allzweckeingänge
SLASEL	I2C-Slave-Adresse auswählen
AFEN	CEN-Chip aktivieren aktiv hoch auf VCM-Treiber-IC
MIPI Schnittstelle	
MDN0 DN0 MD0N DATA_N DMO1N	MIPI 1st negative Ausgabe der Datenspur
MDP0 DP0 MD0P DATA_P DMO1P	MIPI 1st positiver Ausgang der Datenspur
MDN1 DN1 MD1N DATA2_N DMO2N	MIPI 2nd negative Ausgabe der Datenspur
MDP1 DP1 MD1P DATA2_P DMO2P	MIPI 2nd positiver Ausgang der Datenspur
MDN2 DN2 MD2N DATA3_N DMO3N	MIPI 3rd negative Ausgabe der Datenspur
MDP2 DP2 MD2P DATA3_P DMO3P	MIPI 3rd positiver Ausgang der Datenspur
MDN3 DN3 MD3N DATA4_N DMO4N	MIPI 4th negative Ausgabe der Datenspur
MDP3 DP3 MD3P DATA4_P DMO4P	MIPI 4th positiver Ausgang der Datenspur
MCN CLKN CLK_N DCKN	MIPI Uhr negativer Ausgang
MCP CLKP MCP CLK_P DCKN	MIPI Takt positiver Ausgang
DVP Parallel Schnittstelle	
D0 DO0 Y0	DVP Datenausgabeport 0
D1 DO1 Y1	DVP Datenausgabeport 1
D2 DO2 Y2	DVP Datenausgabeport 2
D3 DO3 Y3	DVP Datenausgabeport 3
D4 DO4 Y4	DVP Datenausgabeport 4
D5 DO5 Y5	DVP Datenausgabeport 5
D6 DO6 Y6	DVP Datenausgabeport 6
D7 DO7 Y7	DVP Datenausgabeport 7
D8 DO8 Y8	DVP Datenausgabeport 8
D9 DO9 Y9	DVP Datenausgabeport 9
D10 DO10 Y10	DVP Datenausgabeport 10
D11 DO11 Y11	DVP Datenausgabeport 11

Kamera-Zuverlässigkeitstest

Reliability Inspection Item		Testmethode	Akzeptanzkriterium	
Kategorie	Artikel			
Umwelt	Lager Temperatur	Hoch 60°C 96 Std	Temperaturkammer	Keine anormale Situation
		Niedrig -20°C 96 Std	Temperaturkammer	Keine anormale Situation
	Betriebs Temperatur	Hoch 60°C 24 Std	Temperaturkammer	Keine anormale Situation
		Niedrig -20°C 24 Std	Temperaturkammer	Keine anormale Situation
	Feuchtigkeit	60°C 80% 24 Std	Temperaturkammer	Keine anormale Situation
Thermischer Schock	Hoch 60°C 0.5 Std Niedrig -20°C 0.5 Std Radfahren rein 24 Std	Temperaturkammer	Keine anormale Situation	
Physisch	Falltest (Im freien Fall)	Ohne Verpackung 60cm	10 Mal auf Holzboden	Elektrisch funktionsfähig
		Mit Paket 60cm	10 Mal auf Holzboden	Elektrisch funktionsfähig
	Vibrations Test	50Hz X-Axis 2mm 30 Minuten	Vibrationstisch	Elektrisch funktionsfähig
		50Hz Y-Axis 2mm 30 Minuten	Vibrationstisch	Elektrisch funktionsfähig
		50Hz Z-Axis 2mm 30 Minuten	Vibrationstisch	Elektrisch funktionsfähig
Zugfestigkeit des Kabels Krafttest	Gewicht laden 4 kg 60 Sekunden Radfahren rein 24 Std	Zugprüfmaschine	Elektrisch funktionsfähig	
Elektrisch	ESD-Test	Kontaktaufnahme 2 KV	ESD-Prüfmaschine	Elektrisch funktionsfähig
		Luftentladung 4 KV	ESD-Prüfmaschine	Elektrisch funktionsfähig
	Alterungstest	On/Off 30 Sekunden Radfahren rein 24 Std	Stromschalter	Elektrisch funktionsfähig
	USB-Anschluss	On/Off 250 Mal	Einstecken und ausstecken	Elektrisch funktionsfähig





Inspektionsgegenstand		Untersuchungsmethode	Inspektionsstandard	
Kategorie	Artikel			
Aussehen	FPC oder PCB	Farbe	Das bloße Auge	Größere Unterschiede sind nicht zulässig.
		Zerrissen/gehackt werden	Das bloße Auge	Das Freilegen von Kupferrissen ist nicht zulässig.
		Markierung	Das bloße Auge	Klar, erkennbar (innerhalb von 30 cm Entfernung)
	Halterin	Kratzer	Das bloße Auge	Die Freilegung von Rissen im Inneren ist nicht zulässig
		Lücke	Das bloße Auge	Erfüllen Sie den Höhenstandard
		Schraube	Das bloße Auge	Stellen Sie sicher, dass Schrauben vorhanden sind (falls vorhanden)
		Schaden	Das bloße Auge	Die Freilegung von Rissen im Inneren ist nicht zulässig
	Linse	Kratzen	Das bloße Auge	Keine Auswirkung auf den Auflösungsstandard
		Kontamination	Das bloße Auge	Keine Auswirkung auf den Auflösungsstandard
		Ölfilm	Das bloße Auge	Keine Auswirkung auf den Auflösungsstandard
		Abdeckband	Das bloße Auge	Kein Problem beim Aussehen.
	Funktion	Bild	Keine Kommunikation	Testboard
Helles Pixel			Tafel	Im Image Center nicht erlaubt
Dunkles Pixel			Weißer Tafel	Im Image Center nicht erlaubt
Verschwommen			Das bloße Auge	Nicht erlaubt
Kein Bild			Das bloße Auge	Nicht erlaubt
Vertikale Linie			Das bloße Auge	Nicht erlaubt
Horizontale Linie			Das bloße Auge	Nicht erlaubt
Kleines Leck			Das bloße Auge	Nicht erlaubt
Blinkendes Bild			Das bloße Auge	Nicht erlaubt
Prellung			Inspektionslehre	Nicht erlaubt
Auflösung			Diagramm	Folgt dem Diagrammstandard für ausgehende Inspektionen
Farbe			Das bloße Auge	Kein Problem
Lärm			Das bloße Auge	Nicht erlaubt
Ecke dunkel			Das bloße Auge	Weniger als 100 x 100 Pixel
Farbauflösung			Das bloße Auge	Kein Problem
Abmessungen	Höhe	Das bloße Auge	Follows Approval Data Sheet	
	Breite	Das bloße Auge	Follows Approval Data Sheet	
	Länge	Das bloße Auge	Follows Approval Data Sheet	
	Gesamt	Das bloße Auge	Follows Approval Data Sheet	

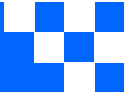

KLT-Paketlösungen

KLT Kameramodul

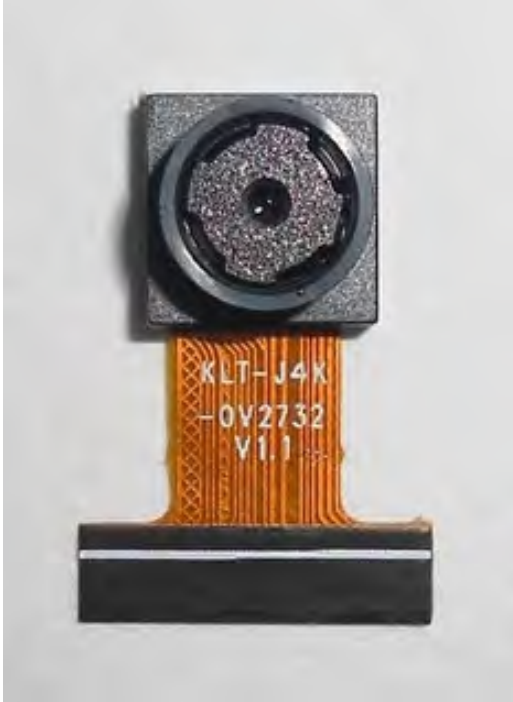

Komplett mit Linsenschutzfolie



Tablett mit Gitter und Raum



Legen Sie die Kameras auf das Tablett

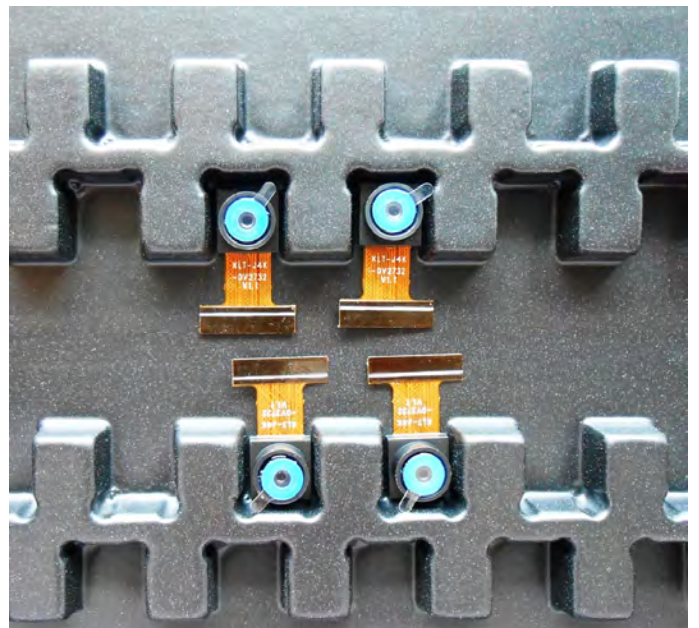

Paketlösung für Kameramodule

Volles Tablett mit Kameras



Abdeckschale mit Deckel



In Antistatikbeutel stecken



Staubsaugen Sie den antistatischen Beutel



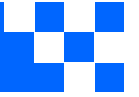

Paketlösung für Kameramodule

Versiegelter Vakuumbbeutel mit Etiketten

1. Modell und Beschreibung 2. Menge 3. Versanddatum 4. Achtung





Paketlösung für große Bestellungen

Schaumstoffplatten zwischen
die Tablettis legen



Schaumstoffplatten sind etwas
größer als Tablettis



Legen Sie Schaumstoffplatten und
Tablettis in die Schachtel



Schaumstoffplatten sind eng anliegende Box



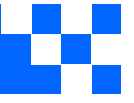

Paketlösung für kleine Bestellungen

Legen Sie die Schaumstoffplatten und
Tablets in die kleine Schachtel



Schaumstoffplatten passen gut in
die kleine Box



Paket in kleiner Box für den Versand



Legen Sie kleine Kartons in größere Kartons





Carbon Box Paketlösung

Verschließen Sie die Carbonbox

Beschriftete Schachtel mit Endverpackung



Versandfertige Karbonbox

1. Lieferadresse und Telefonnummer
2. Box-Nr. und Versanddatum
3. Zerbrechliche Vorsicht



Lösung für Musterbestellungspakete

Legen Sie die Probe in einen kleinen antistatischen Beutel



Stecken Sie die Anschlüsse in den kleinen antistatischen Beutel



Musteretiketten auf dem kleinen Beutel

1. Kameramodul oder Anschlussmodell 2. Lieferdatum und Menge 3. Achtung





Connectors Large Order Package Solution

Steckverbinder in einem Rad



Steckverbinder im Rad beschriften



Das Rad passt perfekt in die Box



Steckerbox versandfertig



Unternehmen Kai Lap Technologies (KLT)

Kai Lap Technologies Group Limited. (KLT) wurde 2009 gegründet und ist ein technologiegetriebener Hersteller der nächsten Generation, der sich auf Forschung, Design und Produktion von Audio- und Videoprodukten spezialisiert hat. KLT verfügt über 20.000 Quadratfuß automatisierte Fabriken mit 100 Mitarbeitern und einem jährlichen Durchsatz von 30.000.000 Kameraeinheiten.

KLT bietet OEM-, ODM-Design, Auftragsfertigung und baut die Kameraprodukte. Sie können uns die Anforderungen auch mit einem Handentwurf übermitteln, unser Vertrieb und unsere Technik arbeiten zusammen, um Ihre Anforderungen zu erfüllen. Wir verstehen uns als Ihr langfristiger Partner bei der Entwicklung praktischer und innovativer Lösungen.

Unser Team deckt alles von der ersten Konzeptentwicklung bis zum Massenprodukt ab. KLT ist spezialisiert auf kundenspezifisches Kameradesign, Rohmaterial, Elektrotechnik, Firmware-/Softwareentwicklung, Produkttests und Verpackungsdesign. Unsere erfahrenen strategischen Versorgungssysteme bieten eine robuste und zuverlässige Fertigungskapazität für Aufträge unterschiedlicher Größe.

**Eingeschränkte Garantie**

KLT gewährt die folgende eingeschränkte Garantie, wenn Sie das/die Produkt(e) direkt von der Firma KLT oder von der Website von KLT, www.KaiLapTech.com, gekauft haben. Produkte, die von anderen Verkäufern oder Quellen gekauft wurden, fallen nicht unter diese beschränkte Garantie. KLT garantiert, dass das/die Produkt(e) bei normalem Gebrauch für einen Zeitraum von einem (1) Jahr ab dem Datum, an dem Sie das Produkt erhalten („Garanzzeitraum“), frei von Material- und Verarbeitungsfehlern sind.

Für alle Produkte, die während des Garanzzeitraums Material- oder Verarbeitungsfehler enthalten oder entwickeln, wird KLT nach eigenem Ermessen entweder: (i) die Produkte reparieren; (ii) das/die Produkt(e) durch ein neues oder generalüberholtes Produkt(e) ersetzen (Ersatzprodukt(e) sind von identischem Modell oder funktionell gleichwertig); oder (iii) Ihnen den Preis erstatten, den Sie für das/die Produkt(e) gezahlt haben.

Diese eingeschränkte Garantie von KLT ist ausschließlich auf Reparatur und/oder Ersatz zu den oben genannten Bedingungen beschränkt. KLT ist nicht zuverlässig oder verantwortlich für nachfolgende Ereignisse.





your BEST camera module partner

KLT Stärke

Leistungsstarke Fabrik



Professioneller Service



Versprochene Lieferung

